



DATOS MOTOR

POTENCIA	0.25HP
REVOLUCIONES	1760
FRECUENCIA	60HZ
TORQUE MOTOR NOMINAL	1,01
CARCASA (PAM)	63(B5)
TIPO BRIDA	FF-115
EFICIENCIA MOTOR	IE 2

DATOS REDUCTOR

REFERENCIA	541096
TIPO	ORTOGONAL
MODELO	FCN
MATERIAL	ALUMINIO
CARCASA	40
RELACION DE TRANSMISION i:	40
VELOCIDAD SALIDA	44,00
TORQUE MAXIMO	41
TORQUE OPERACIÓN	26
FACTOR DE SERVICIO	1,6

PLANOS REDUCTOR

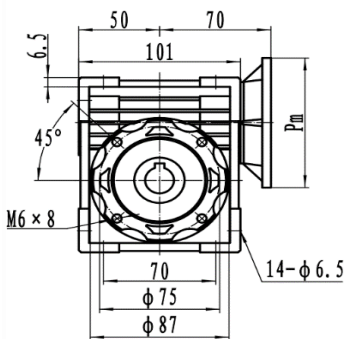

FCN 40

Input shaft hole

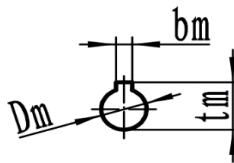

Output shaft hole

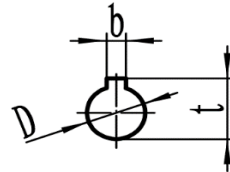

Dimensions of output shaft				
D	H7	b	D10	t
18		6		20.8

	Pm	Dm	bm	tm
56B5	120	9	3	10.4
63B5	140	11	4	12.8
63B14	90			
71B5	160	14	5	16.3
71B14	105			

